

VSAOF

Oblong suction cup with 1.5 bellow Specifically designed for cheese



Industry-specific applications



Types of use





To meet the requirements of applications for handling soft and fragile food products such as soft cheese, COVAL has developed a 1.5 bellow oblong suction cup made of food-grade silicone that can be fitted with a stainless steel grid, which prevents deforming the food product.

- Suction cup made of 50 Shore A blue silicone that complies with food standards (FDA and CE 1935/2004).
- 1.5 bellow
- Dimensions: 65 x 150 mm

Materials

SIBL5 50 Shore A blue silicone

Suction Cup Characteristics

	Dim. (mm)	 (cm ³)	 (N) ⁽¹⁾
VSAOF65150SIBL5	65x150	298	51.5

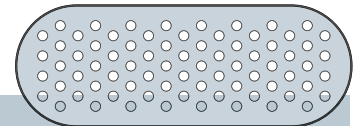
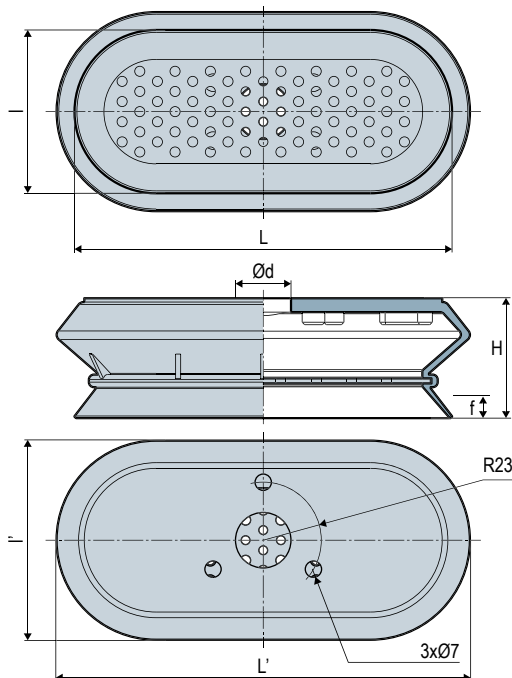

(1) Actual force of suction cup in use with 20% vacuum and including a safety factor of 2.

Dimensions



Accessory

Stainless steel grid for suction cup
VSAOF65150:
Part no.: 80002470
Weight: 80 g

	L	I	L'	I	Ø d	f ⁽²⁾	 (g)
VSAOF65150SIBL5	149.8	64.8	164	79	22	26	124

(2) f = Deflection of suction cup.



Specify the part number: **VSAOF65150SIBL5**
+ stainless steel grid Part no. 80002470

The values represent the average characteristics of our products.
Note: All dimensions are in mm