

VSAF

Suction cup with 1.5 bellow Specifically designed for cheese

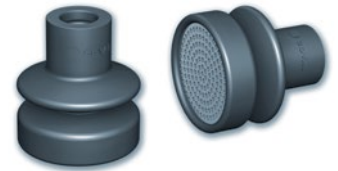

Industry-specific applications



Types of use





To meet the requirements of applications for handling soft and fragile food products such as soft cheese, COVAL has developed a 1.5 bellow suction cup made of food-grade silicone that can be fitted with a stainless steel grid, which prevents deforming the food product.

- Suction cup made of 50 Shore A blue silicone that complies with food standards (FDA and CE 1935/2004).
- 1.5 bellow
- Ø 50 mm

Materials

SIBL5 50 Shore A blue silicone

Suction Cup Characteristics

	Ø (mm)	 (cm ³)	 (lbf) ⁽¹⁾
VSAF50SIBL5	50	24.1	4.27

(1) Actual force of suction cup in use with 20% vacuum and including a safety factor of 2.

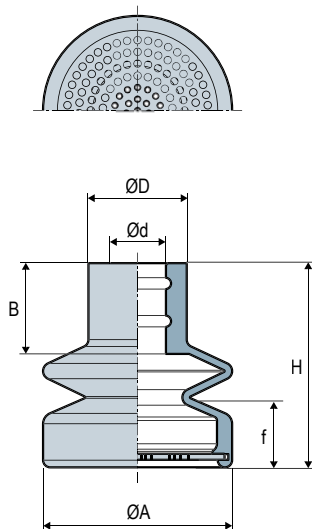

Dimensions

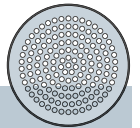

Accessory

Stainless steel grid 50 mm in diameter for suction cup VSAF50:
Part no.: 80002171
Weight: 18 g



	Ø A	H	Ø d	Ø D	B	f ⁽²⁾	 (g)
VSAF50SIBL5	50	54	15	26	24	11	28

(2) f = Deflection of suction cup.



Specify the part number: **VSAF50SIBL5**
+ stainless steel grid Part no. 80002171

The values represent the average characteristics of our products.
Note: All dimensions are in mm